

SmartClean HEO Filter

Automatic Flushing Mechanism

Automatic flushing according to pressure differential and/or time with motorized mechanism

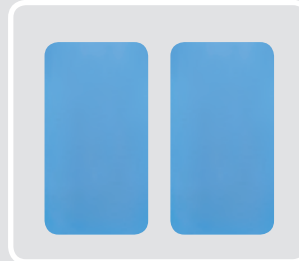
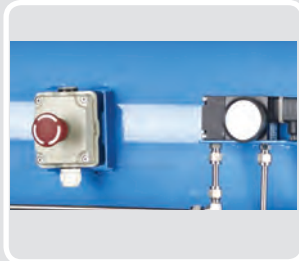

Two coat electrostatic powder coating

Two coat electrostatic powder coating thickness of 150-200 micron to provide best environmental protection.

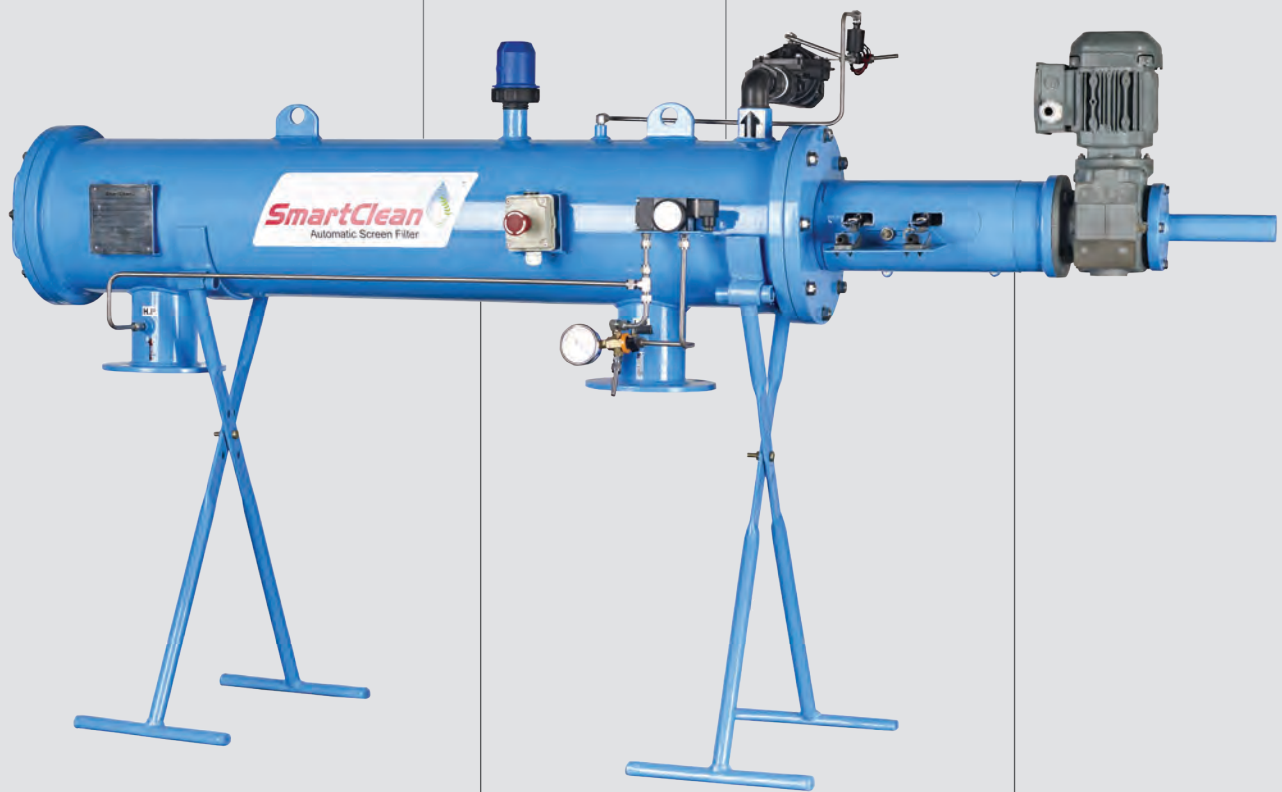

Choice of Filtration Degree

Filtration available with following degree as 80, 100, 125, 200 & 300 micron

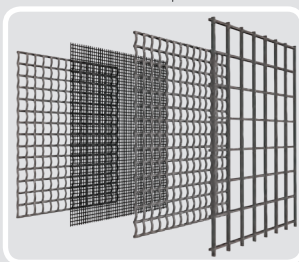

Self-Suction Cleaning Mechanism

Cleaning of the filter is carried out by the suction smart scanner which rotates spirally across the screen



SmartClean HEO Filter

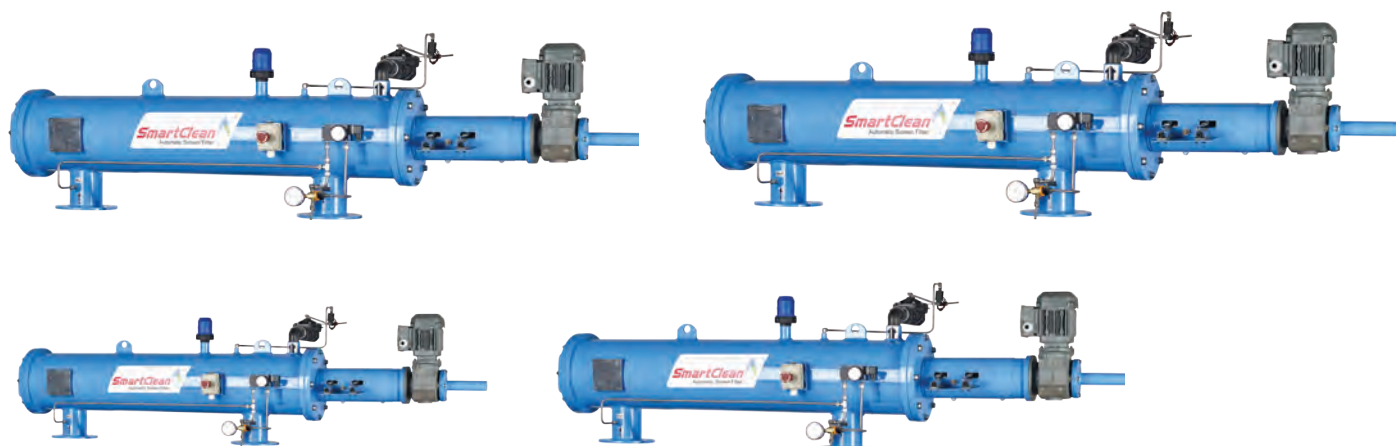

Specifications

Model	Type	40R	60R	80R	100R
Inlet /outlet connection (inch)	inch	4"	6"	8"	10"
Filtration area	(cm ²)	5000	5000	6800	6800
	(inch ²)	775	775	1054	1054
Nominal Flowrate	m ³ /hr	100	200	270	280
	US gpm	440	880	1188	1232
Filtration Degree	micron	80, 100, 125, 200, 300			
Minimum Working Pressure	bar	2			
	psi	28			
Maximum Working Pressure	bar	10			
	psi	142			
Maximum Working Temperature	Deg C	60			
	Deg F	140			
Gross Weight	kg	172	202	240	245
	lbs	178	444	528	539

Screen Type	Multilayer dutch weave screen				
-------------	-------------------------------	--	--	--	--

Drain Connection Size	Inch	1.5"	2"		
Minimum Flow for Flushing (at 2 bar - 29 psi)	m ³ /hr	14	21	24	36
	US gpm	62	92	106	158
Volume of Flush Water (at 2 bar - 29 psi)	liter	80	117	134	200
	gallon	21	31	35	53
Duration of Flushing	sec	20	20	20	20
Flushing Condition	Automatic based on differential pressure of 0.6 bar (8.5 psi) and /or time based				

Filter construction materials	
Filter housing	Epoxy coated carbon steel ASTM - A53 / A106 (Stainless steel 316L on request)
Filter Lid	Epoxy coated carbon steel ASTM - A53 / A106 (Stainless steel 316L on request)
Housing seal	EPDM & NBR
Cleaning Mechanism	Collecting Shaft: Stainless Steel 316L; Nozzle: Nylon
Filter Element	Stainless Steel 316L
Drain Valve	PP

SmartClean HEO Filter

Model 40R

4" HEO FILTER ASSEMBLY

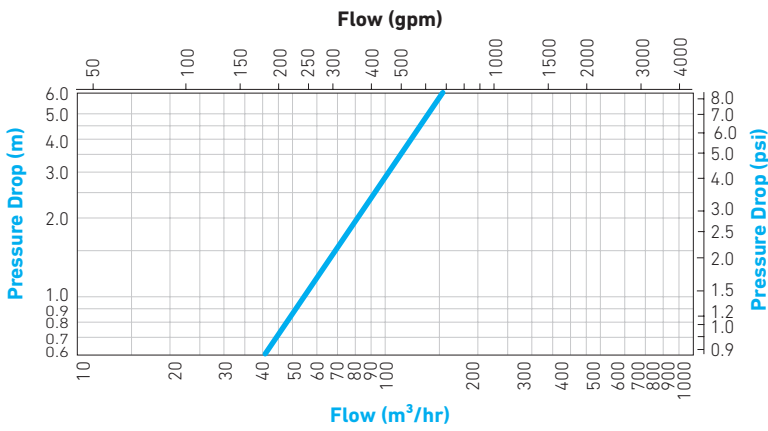
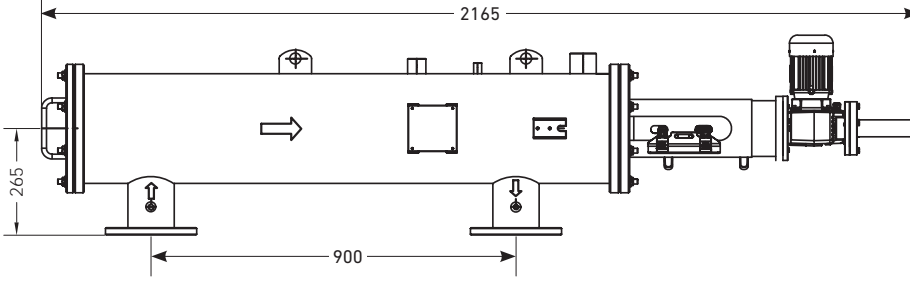

Model 60R

6" HEO FILTER ASSEMBLY

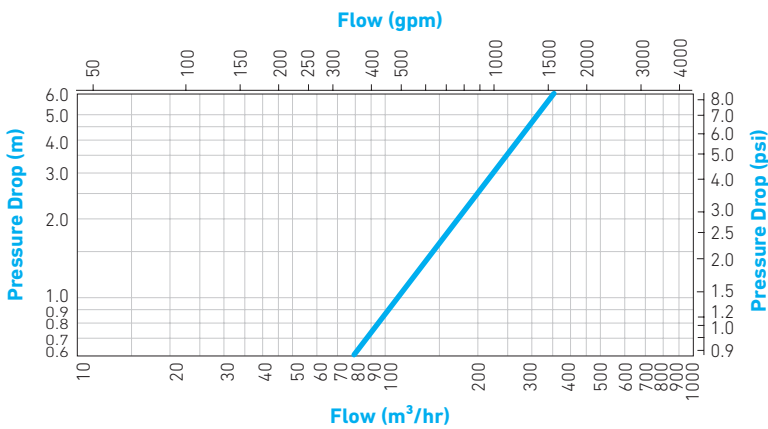
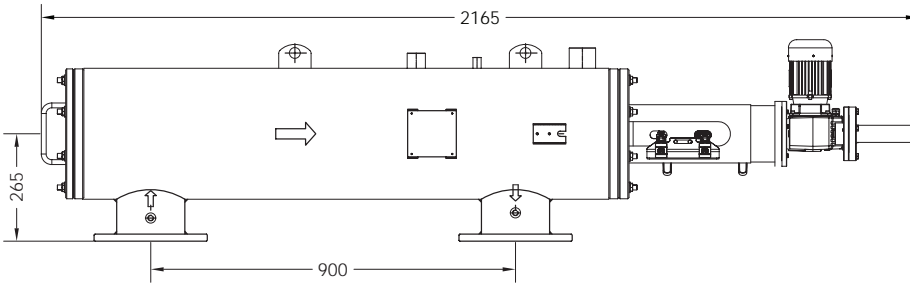

SmartClean HEO Filter

Model 80R

8" HEO FILTER ASSEMBLY

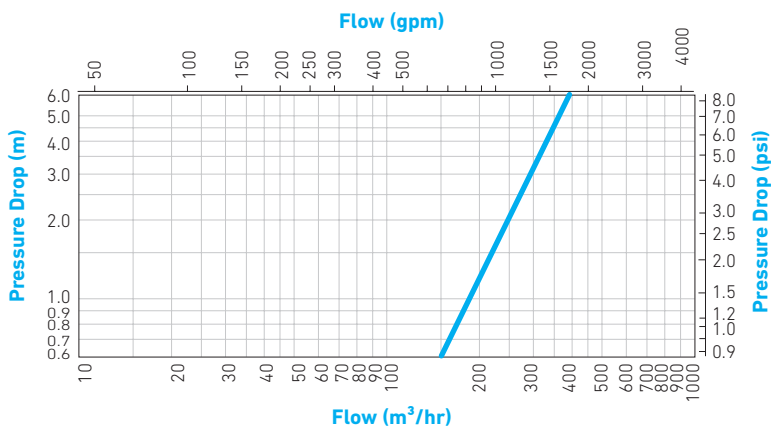
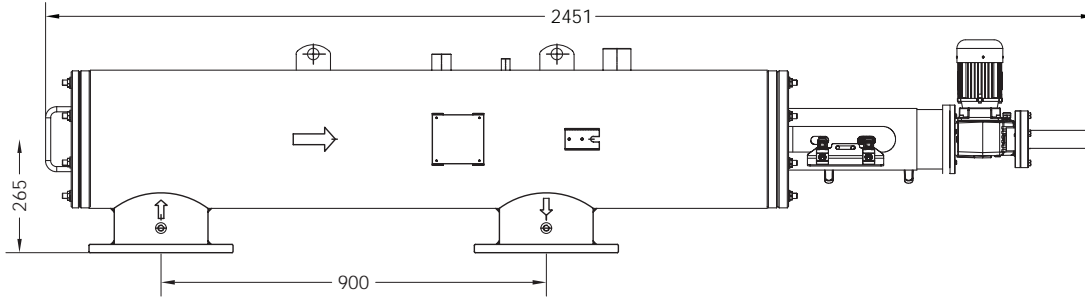

SmartClean HEO Filter

Model 100A

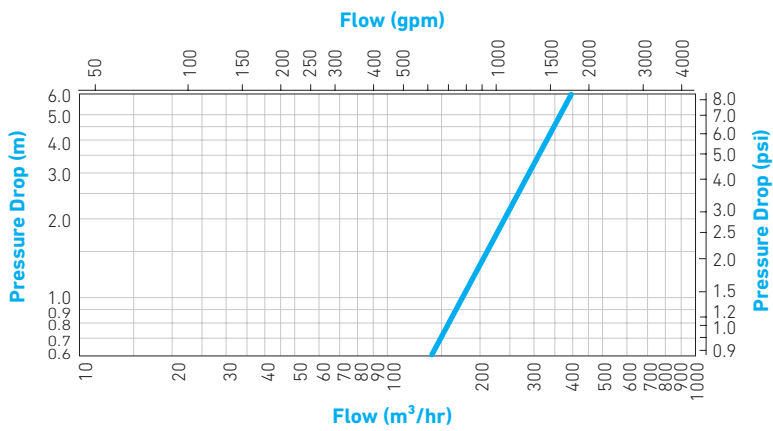
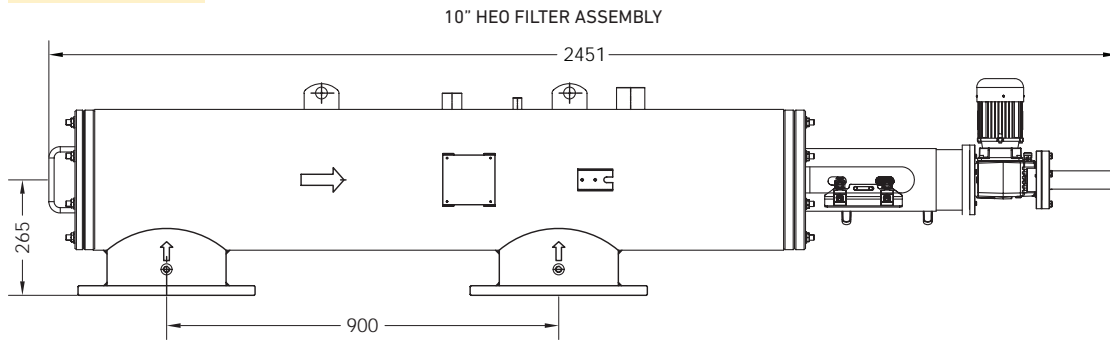

SmartClean HEO Filter

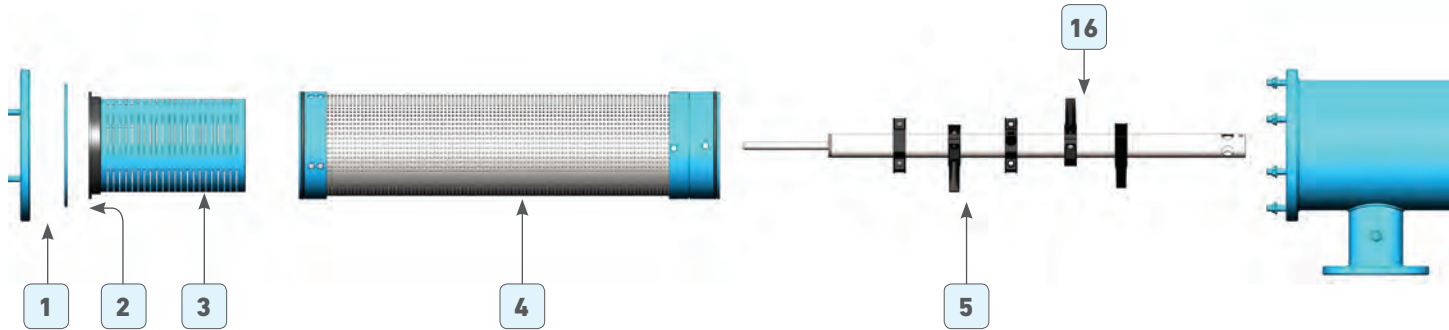

Spare Part Guide

Sr. No.	Description	Model		
		40R	60R	
1	Filter Side Cover	JSSH0SCC	JSSH0SCC	
2	Filter Side Cover "O" Ring	EPDMORINGID2468CS7	EPDMORINGID2468CS7	
3	SmartClean Prefilter / Coarse Filter	JSCHEOPRIFILTERA	JSCHEOPRIFILTERA	
4	SmartClean Filter Element	JSCHHOSCRA5000A	JSCHHOSCRA5000A	
5	Dirt Collecting Shaft Assembly	JSCHEOCSA5000A	JSCHEOCSA5000A	
6	Filter Body	JSCHEO100BC	JSCHEO200BC	
7	Cover Flange Assembly	JSCHEODSCFC	JSCHEODSCFC	
8	"O" Ring for EO assembly	SUDSEAL30X38X7	SUDSEAL30X38X7	
9	Drive Shaft Case Assembly	JSCHEODSCA	JSCHEODSCA	
10	Drive Shaft Case Cover	DRSTCSCO	DRSTCSCO	
11	Electric Motor	GMSAF47DRS71S4FT	GMSAF47DRS71S4FT	
12	Filter Protection Cover	PROCO	PROCO	
13	Tubing assembly kit	SS Tubing	JSCHEO5SSTUBEASLY	JSCHEO5SSTUBEASLY
		PE Tubing	JSCHEO5PETUBEASLY	JSCHEO5PETUBEASLY
14	Controller	JSCHEOEMSWBA	JSCHEOEMSWBA	
15	Differential Pressure Switch	PDSWDGC320GS	PDSWDGC320GS	
16	Suction Nozzle	JSCNOZZLEASSLY	JSCNOZZLEASSLY	
17	Air Release Valve	ARVC100	ARVC100	

SmartClean HEO Filter

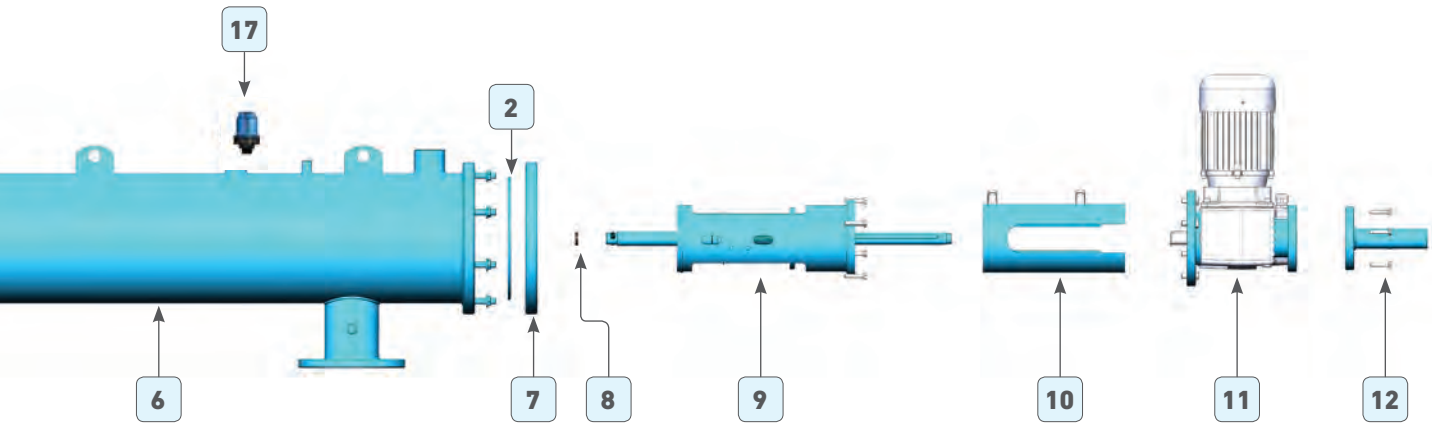

Sr. No.	Description	Model		
		80R	100R	
1	Filter Side Cover	JSSHOSCC	JSSHOSCC	
2	Filter Side Cover "O" Ring	EPDMORINGID2468CS7	EPDMORINGID2468CS7	
3	SmartClean Prefilter / Coarse Filter	JSCHEOHFPRIFILTERA	JSCHEOHFPRIFILTERA	
4	SmartClean Filter Element	JSCHEO5CRA6800A	JSCHEO5CRA6800A	
5	Dirt Collecting Shaft Assembly	JSCHEOCSA6800A	JSCHEOCSA6800A	
6	Filter Body	JSCHEO300BC	JSCHEO400BC	
7	Cover Flange Assembly	JSCHEODSCFC	JSCHEODSCFC	
8	"O" Ring for EO assembly	SUDSEAL30X38X7	SUDSEAL30X38X7	
9	Drive Shaft Case Assembly	JSCHEODSCA	JSCHEODSCA	
10	Drive Shaft Case Cover	DRSTCSCO	DRSTCSCO	
11	Electric Motor	GMSAF47DRS71S4FT	GMSAF47DRS71S4FT	
12	Filter Protection Cover	PROCO	PROCO	
13	Tubing assembly kit	SS Tubing	JSCHEO68SSTUBEASLY	JSCHEO68SSTUBEASLY
		PE Tubing	JSCHEO68PETUBEASLY	JSCHEO68PETUBEASLY
14	Controller	JSCHEOEMSWBA	JSCHEOEMSWBA	
15	Differential Pressure Switch	PDSWDGC320GS	PDSWDGC320GS	
16	Suction Nozzle	JSCNOZZLEASLY	JSCNOZZLEASLY	
17	Air Release Valve	ARVC100	ARVC100	